

1		
Description	Material	Finish
Nut	Brass	Nickel
Washer	Brass	Nickel
Main Body	Brass	Nickel
Pin Insulator	Teflon	Teflon
Pin	Brass	Gold
Spacer	Teflon	Teflon
Shield Sleeve	Brass	Nickel
Retaining Nut	Brass	Nickel
Crimp Ring	Brass	Nickel

RECOMMENDED CABLE STRIPPING DIMENSIONS

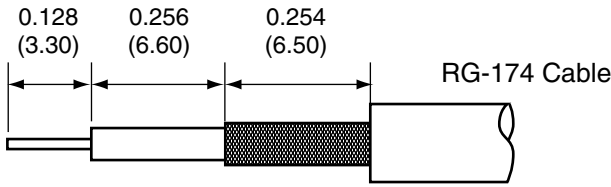

RECOMMENDED MOUNTING HOLE

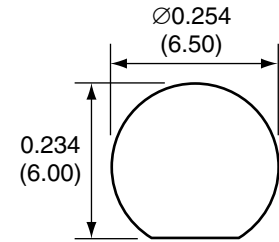

SIDE VIEW

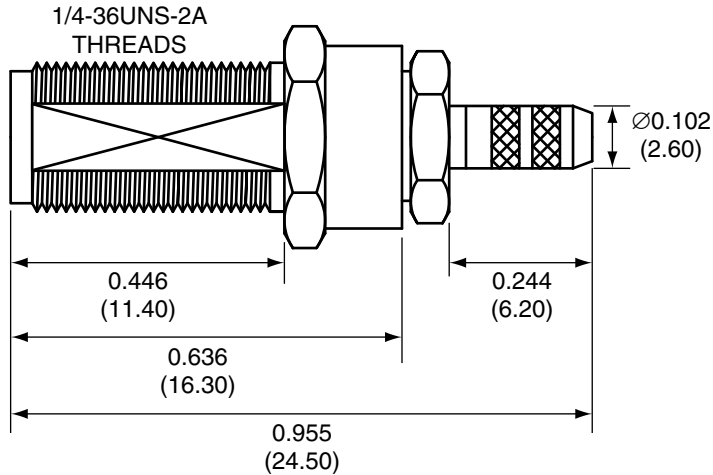

PIN

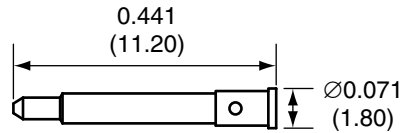

CRIMP RING

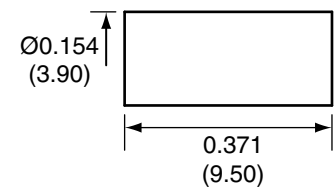

WASHER

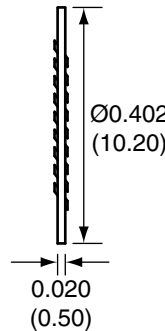

NUT

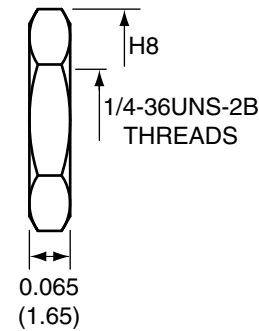

CONREVSMA005 ASSEMBLY INSTRUCTIONS

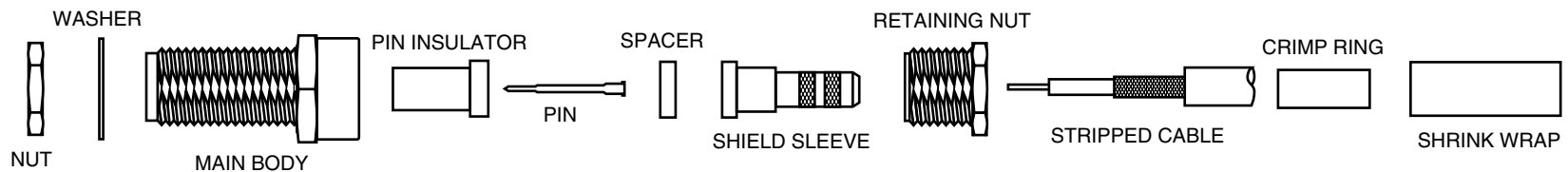

1. Insert the center conductor through the retaining nut, shield sleeve, and spacer.
2. Solder the pin to the center conductor.
3. Insert the pin into the pin insulator, then screw the main body onto the retaining nut.
4. Wrap the braid around the tail of the body and crimp the ring with a 0.137" hex crimp tool (or one labeled for use with RG-174 cable).
5. Use the shrink wrap to cover the crimp ring.
6. Use the nut and washer to secure the connector to a case.

Title RP-SMA FEMALE BULKHEAD MOUNT
CABLE END CRIMP FOR RG174 CABLE

Part No. CONREVSMA005 Revision: 1.0

Dimensions: INCHES (mm) Date: 3/2/2005

CONNECTOR CITY
159 ORT LANE
MERLIN, OR 97532
PH (541)-471-6256
FAX (541)-471-6251

CONNECTOR CITY
THE VALUE OF CONNECTIONS

Sheet 1 of 1